



Instruction manual

M1200E

Multilogger

© Copyright: COMET SYSTEM, s.r.o.

It is prohibited to copy and make any changes in this manual, without explicit agreement of company COMET SYSTEM, s.r.o. All rights reserved.

COMET SYSTEM, s.r.o. makes constant development and improvement of their products. Manufacturer reserves the right to make technical changes to the device without previous notice. Misprints reserved.

Contact the manufacturer of this device:

COMET SYSTEM, s.r.o.
Bezrucova 2901
756 61 Roznov pod Radhostem
Czech Republic
www.cometsystem.com

Content

INTRODUCTION.....	4
GENERAL SAFETY PRECAUTIONS	6
GETTING STARTED.....	7
Multilogger in portable application	7
Multilogger in stationary application	8
INSTALLATION INSTRUCTION.....	9
Recommendations for mounting	11
INPUTS OF MULTILLOGGER	13
POWER SUPPLY OF MULTILLOGGER	14
KEYBOARD OPERATION.....	17
Control and indication parts	17
Basic display operation	18
Main menu	20
CONNECTING WITH THE COMPUTER	24
SOFTWARE COMET VISION	25
DEVICE SETUP USING SOFTWARE	27
Device configuration basics	27
Device configuration items	27
APPLICATIONS NOTES	34
OPERATION AND MAINTENANCE RECOMMENDATIONS.....	38
TECHNICAL PARAMETERS.....	41
Power supply	41
USB communication interface	43
Measuring, data memory and real time clock	43
Electromagnetic compatibility	44
Operation and storage conditions	44
Mechanical characteristics	45
Technical parameters of the inputs	45
APPENDIXES	48
Appendix 1: Selected error messages.....	48
Appendix 2: Input circuits	50

Introduction

The Multilogger has been designed for measuring and recording physical and electric quantities with an adjustable logging interval from 1 second to 24 hours. The device is equipped with 4 inputs (connectors) for external probes or signals. The Multilogger can be used either as stationary or portable device.

The device allows for:

- Measuring and processing input quantities; the maximum number of the measured and calculated quantities is 16.
- Finding and storing minimal and maximal values for each measured quantity (since their last manual reset).
- Acquiring autonomous time record of measured values, independent of the mains supply. Recorded values can be stored as separate samples in the recording time or as average/ minimal/maximal values during the logging interval. Recording may be continuous, or only during an alarm optionally.
- Creating alarm states and perform actions (audio and optical signalization).
- Powering by batteries (NiMH accumulators or alkaline batteries).
- Powering by external power supply, which can be also used for charging NiMH accumulators (optional accessory).

Multilogger drawing:

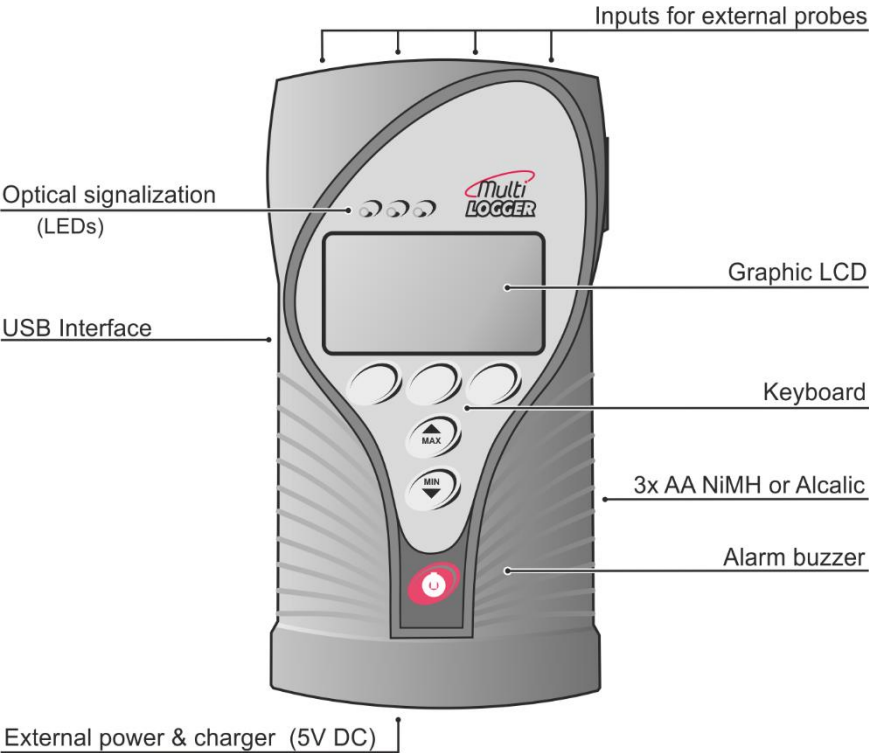

General safety precautions



The following list of precautions serves to reduce risk of injury or damage of described instrument. To prevent injuries use instrument accordingly with rules in this manual.

- **Installation and service need to be performed by qualified persons only.**
- **Use** a suitable power supply. Use power supplies only with a voltage recommended by the manufacturer (+5V DC) and approved in accordance with proper standards. Pay attention, the source has undamaged cables or cover.
- **The device** and power supply must not be used in a humid and hazardous environment (such as bathrooms), at locations exposed to direct sunlight and to other heat sources, thus preventing damages and deformation of the cover.
- **Do not use the instrument without its covers.** Do not remove the covers from the device.
- **Do not use** the instrument if it does not work correctly. If you think, that the device is not working correctly, let check it by qualified service person.
- **Never** charge batteries that are not rechargeable.
- Do not use **the device in explosive environment.**

Getting started

Multilogger in portable application

- **Connect the appropriate probes and signals to the device** - for more information, see Chapter *"INPUTS OF MULTILOGGER"*.
- **Switch on the Multilogger** - push the switch button on the device. The display lights and the instrument starts working. For more information, see Chapter *"POWER SUPPLY OF MULTILOGGER"*.
- **Install Comet Vision software to your computer** - it is available for free at www.cometsystem.com/products/software
- **Connect Multilogger with your PC** - for more information, see Chapter *"CONNECTING WITH THE COMPUTER"*.
- **Device settings** - use SW to set up the device in accordance with the connected probes and your requirements. If you are not going to use the device soon, turn it off. For more information, see Chapter *"DEVICE SETUP USING SOFTWARE"*.
- **Measurements** - remove the Multilogger from the transportation case, connect probes and external power adapter (if needed) and turn the device on. Some device settings can be changed from its keyboard. When measurement ends, move the device to your computer room and download the recorded data to PC. For more information, see Chapter *"KEYBOARD OPERATION"*.
- **Charging batteries** - if the Multilogger includes rechargeable batteries, you can recharge them when needed. For more information, see also Chapter *"POWER SUPPLY OF MULTILOGGER"*.
- **Maintenance and periodic inspections** - In order to secure reliable operation of the device, it is recommended to make regular inspections. For more information, see part *"OPERATION AND MAINTENANCE RECOMMENDATIONS"*.

Multilogger in stationary application

- **Select a suitable location for placing of the Multilogger** - pay attention to parameters of ambient environment, minimize the number of cables, avoid sources of interferences. For more information, see Chapter *“INSTALLATION INSTRUCTIONS”*.
- **Mounting of sensors and routing of cables** - pay attention to rules of theirs installation, use recommended working positions, keep enough distance from high power devices and cables.
- **Connect the appropriate probes and signals to the device** - for more information, see Chapter *“INPUTS OF MULTILOGGER”*.
- **Switch on the Multilogger** - push the switch button on the device. The display lights and the instrument starts working. For more information, see Chapter *“POWER SUPPLY OF MULTILOGGER”*.
- **Install the *COMET Vision* software to your computer** - it is available for free at www.cometsystem.com/products/software
- **Connect Multilogger with your PC** - for more information, see Chapter *“CONNECTING WITH THE COMPUTER”*.
- **Device settings** - use *COMET Vision* software to set up the device in accordance with the connected probes and your requirements. For more information, see Chapter *“DEVICE SETUP USING SOFTWARE”*.
- **Maintenance and periodic inspections** - In order to secure reliable operation of the device, it is recommended to make regular checks. For more information, see part *“OPERATION AND MAINTENANCE RECOMMENDATIONS”*.

Installation instruction

Location of Multilogger must match the operating conditions and not allowed manipulations.

Working position of the device:

- Multilogger placed on a horizontal, nonflammable surface.
- Multilogger fixed on the wall from nonflammable materials or in a low-current switchboard using the holder - the working position is with input connectors upwards.

Device dimensions:

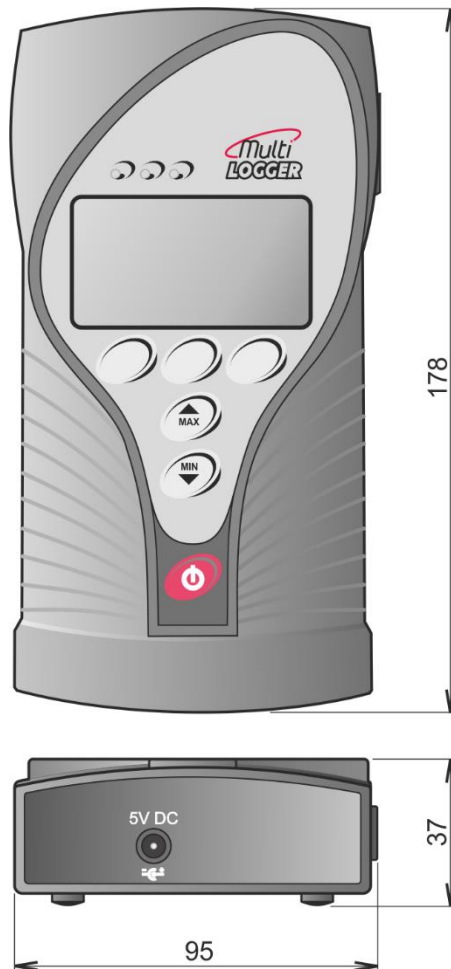

The way of mounting the holder to Multilogger and mounting holes dimensions:

MLP001

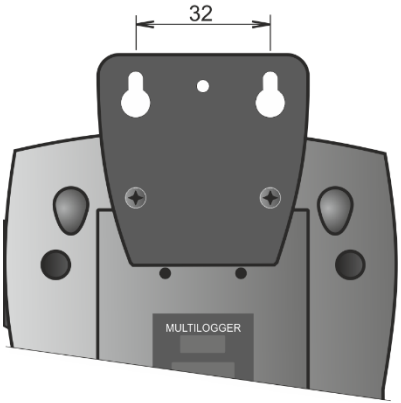

MLP002

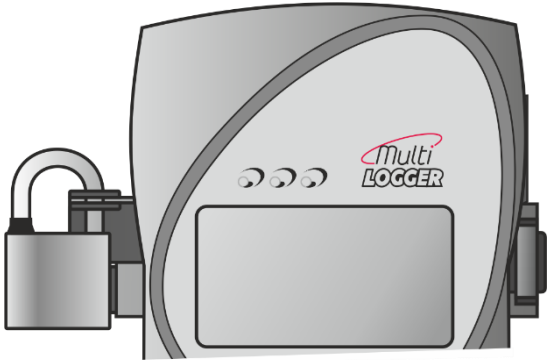
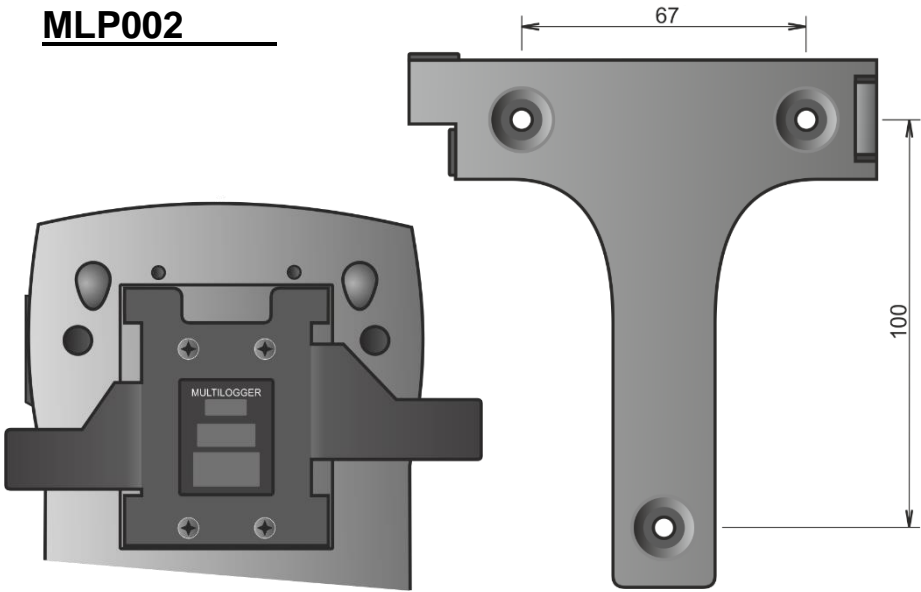

Recommendations for mounting

- **Do not mount Multilogger near sources of interference** (Multilogger must not be mounted directly to power switchboard nor to its nearness. Also do not mount data logger near power contactors, motors, frequency converters and other sources of strong interference).

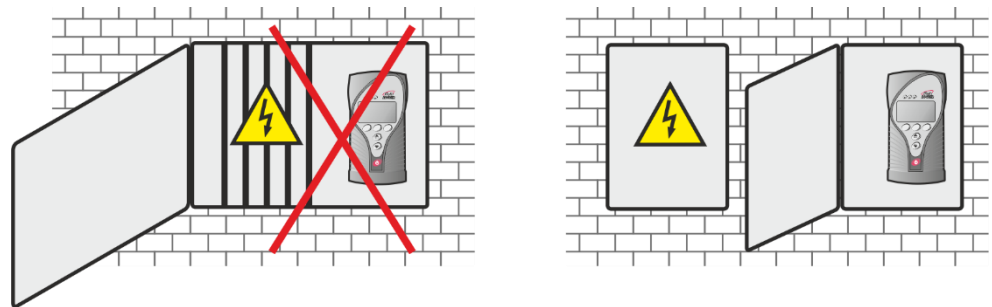

- **In cable routing** follow rules of standards for installation of low current distribution (EN 50174-2), especially it is necessary to pay attention to avoid electromagnetic interference intrusion to the leads, transmitters, transducers and sensors. Do not locate cabling near sources of interference.
- **Do not use leads in parallel with power distribution network leads**

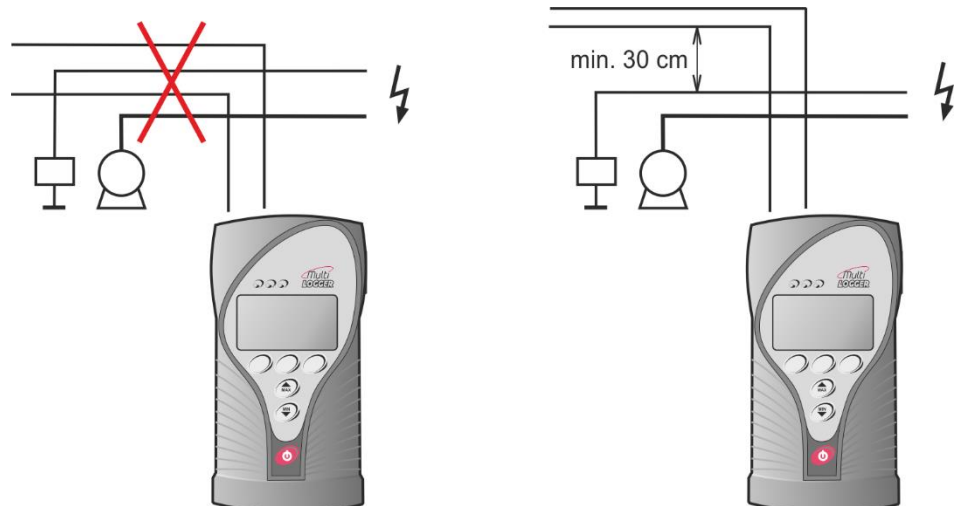

-
- Do not interconnect the inputs with other measuring systems.

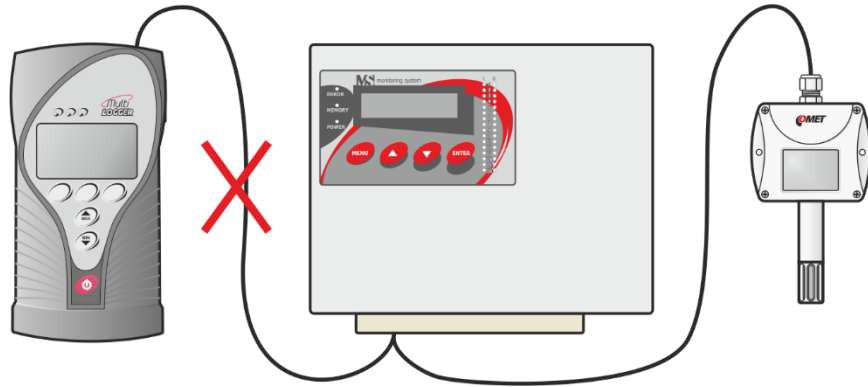

- Do not use common leads for several inputs.

Inputs of Multilogger

Universal input with miniature thermocouple connector:

- thermocouples of the K, J, S, B, T and N types
- DC Voltage -18 mV to +18 mV
- DC Voltage -60 mV to +140 mV

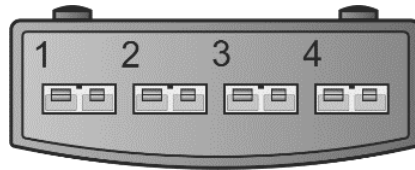

Plug properly oriented connector to the input of Multilogger. The connector is mechanically coded using a wider pin. Use the white uncompensated connector for measuring voltage. Make sure that the wires are not connected to any other conductive parts! Electrical coupling among thermocouples can cause large measurement errors or instable values! To obtain correct measurement values, the Multilogger has to be temperature-stabilized!

Marking of subminiature thermocouple connectors and wires manufactured by OMEGA (in accordance with US standard):

Thermocouple type	Connector color	+ wire color	- wire color
K (Ni-Cr / Ni-Al)	Yellow	Yellow	Red
J (Fe / Cu-Ni)	Black	White	Red
S (Pt-10 % Rh / Pt)	Green	Black	Red
B (Pt-30 % Rh / Pt-6 % Rh)	Gray	Gray	Red
T (Cu / Cu-Ni)	Blue	Blue	Red
N (Ni-Cr-Si / Ni-Si-Mg)	Orange	Orange	Red

Two voltage ranges are available on each universal thermocouple connector for measuring small voltages:

- range -60 mV to +140 mV
- range -18 mV to +18 mV

Use the white uncompensated connector connected according to the picture.

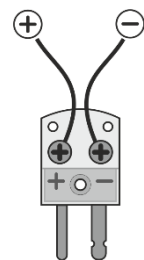

The Multilogger does not have galvanically isolated inputs. For this reason, only devices that are not connected to any other circuit may be connected to the inputs of Multilogger. Simplified circuit diagram of inputs is shown in *Appendix 2*.

Power supply of Multilogger

The Multilogger is powered from three AA batteries and optionally also from an external +5 V DC power supply, which can be also used for charging the batteries.

External power supply

- External power supply can be connected to the Multilogger in several ways:
 - a) to the power supply connector on the bottom of Multilogger (for example AC adapter)
 - b) via USB cable connected to PC (it will work only if the USB port of the PC has current sufficiency to power the Multilogger)
- No energy from the batteries is discharged if external source is present.



ATTENTION - never connect voltage greater than 5.5 V to the external power supply input - it could damage the device.

Batteries

- The Multilogger is equipped with alkaline batteries.



ATTENTION - if you insert the NiMH charging batteries to the Multilogger, change the battery model to NiMH in the device configuration. Never charge batteries that are not rechargeable!

- Charging batteries:
 - a) batteries can be charged if an external power source is connected
 - b) the charging process will start if the NiMH charging accumulators are selected in the device configuration
 - c) when the Multilogger is turned off, the batteries cannot be charged
 - d) the Multilogger allows for two battery charging modes - high current **fast charging** mode and low current **slow charging** mode

-
- Slow low current charging mode is mainly used for stationary installations. Batteries work as a backup source in case of external power failure. Charging is automatically activated after restoring of external power supply. During slow charging device operates normally. Recharging of completely discharged battery takes several days, however, in normal operation, do not expect a completely discharged battery. The charging process is indicated on the device display using the corresponding symbol .
 - Fast high current charging mode is mainly used for portable applications. Discharged batteries can be recharged within a few hours. The charging procedure has to be activated by the service personnel:
 - a) If the Multilogger is on, switch it off. Connect an external power supply to the device.
 - b) Press down and hold (approximately 3 seconds) the red On/Off key on the Multilogger until you see “NiMH charger” on the device display. The charging process is started.
 - c) During fast charging Multilogger does not work in the normal operating mode, does not take measurements and does not communicate with the PC.
 - d) Once the charging process is completed, the Multilogger displays the “Batteries charged” message and you can turn it off.
 - e) The charging can be proceed within a temperature range of 0 °C to +40 °C only. If the temperature is out of this range, the charging process is automatically stopped.
 - Battery replacement:

If you want to keep the correct time setting in your device, do not let the battery discharge completely.

When replacing the battery, do it quickly. The timer circuit runs without battery for max. 5 minutes if the device is switched off.

 - a) Switch the Multilogger off.
 - b) Remove the battery cover, take out the old batteries and insert new batteries (take care for correct polarity). Battery polarity is shown on its holder.
 - c) Switch the Multilogger on and make sure the set time is correct (device menu *View settings - General settings*).

-
- d) If you change the battery chemistry (rechargeable <=> non- rechargeable), **you have to** make this change in the device configuration also.

Note: The Multilogger can operate with removed batteries powered externally. This is not a standard use of the device but it is possible. In this case, the full battery is displayed. Interruption of power supply causes loss of time setting.

Keyboard operation

Control and indication parts

The front panel of the Multilogger includes 6 keys, 3 indication LED diodes and a graphic display.

- The red key with the switch symbol is used for Multilogger turning on/ off. The MIN/MAX keys (with the arrows) are used for quick show of the minimal and maximal measured values and also for moving through menu items. Function of keyboard upper row buttons is defined by actual description of each button on the lower LCD line display.
- The indication LED diodes inform us about the current state of alarms and allows the operation personnel to observe this important information even under low light and from a greater distance.

green LED	no active alarms, "everything is OK"
orange LED	one alarm is active
red LED	several alarms are active or a system alarm (device malfunction)

- The green LED ("everything is OK") can be deactivated in device configuration to save energy. The indication LEDs can be enabled permanently or can be set to a blinking mode in battery mode to save energy also. If the measured quantity has both alarms set into the same direction, the LED diodes will indicate the current level of value: green - everything is OK, orange - exceeding the lower limit, red - exceeding the upper limit.

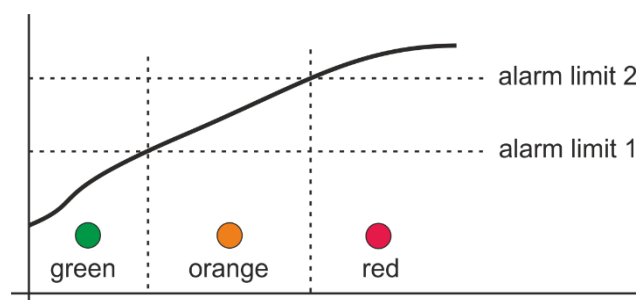

- The LEDs show an overview about all active alarms in the Multilogger. In the device configuration, we can assign individual alarms to the LED diodes for customizing the indication to our needs.

Basic display operation

Current measured values (or min/max) and their units are shown on the device display. To make it easier, the short description of measured quantity, the corresponding input number or a user description of the input, can be optionally displayed. Using the VIEW multifunction key, you can switch among these views on the display. You can choose from 3 different display options: input number + short description of measured quantity, input number without the short description of measured quantity and channel number + short description of measured quantity. If the Multilogger setup allows it, audio signaling of the currently active alarms can be temporarily muted using the MUTE multifunction key.

Numerical values of the measured quantities can be optionally displayed in three different font sizes according to user needs. When the smallest font size is selected, up to 6 quantities can be displayed together. When the largest font size is selected, the maximum number of the quantities that can be displayed together is 2. The maximum range of numerical values on the display is 7 characters (including the decimal point and sign "minus"). Exceeding this range is indicated as several dashes (-----), recording, however, is still running correctly.















When the Multilogger is set for measuring more quantities or calculated channels, their viewing can be cyclically switched using the multifunction CHANN key. The order of the displayed quantities can be modified as needed.

The bell icon on the line of the measured value indicates an active alarm for this quantity.



The status line of the display shows icons that indicate the current status or device mode:

- FULL** full memory of non-cyclic record
- LOG** active recording

	active recording of analog values (in the “during alarm only” or “controlled by an external input” recording modes)
	inactive recording of analog values (in the “during alarm only” or “controlled by an external input” recording modes)
	external power supply present (if the status line is occupied by icons of a higher priority, it is not displayed)
	minimal measured values are displays
	maximum measured values are displays
	approximately one half of the battery capacity remaining
	battery is discharged, it needs to be replaced (alkaline batteries) or recharged (NiMH accumulators)
	battery charging in progress
	the data memory limit exceeded
	low voltage of the real time clock circuit detected, the time could be incorrect!
	alarm at least on one channel (the particular channel is marked with a bell by the given value)
	system alarm (alarm sources can be found in the System information menu)
	downloading of recorded data in progress (it is not displayed for MIN/MAX view mode)
	the Multilogger is being configured from a PC or via the web (it is not displayed for MIN/MAX view mode)

Main menu

Some device settings can be viewed or modified directly on the device using the keyboard.

- Main menu items:
1. System Information
 2. Viewing settings
 3. Change the Display
 4. Device Settings
 5. Clear Min/Max
 6. Clear Latched alarm
 7. Device information

1. System information

This menu item shows information that does not a part of device configuration and that describes the current status of the Multilogger:

- System alarm sources specify, what problem has caused the alarm, indicated by icon **! ALARM** on the display.
 - a) The **dash** next to the item description means that this item is not enabled for evaluation in the device configuration.
 - b) The **tick** next to the item description means that this item is enabled in the device configuration and that it is OK.
 - c) The **exclamation mark** next to the item description means that this item is enabled in the device configuration, however, it is not associated to the LED, audio or alarm signal indication and it is in error state.
 - d) The **bell** next to the item description means that this item is enabled in the device configuration, and it is associated to the LED, audio or alarm signal indication and it is in error state.
- System information items:
 - a) Remaining battery capacity (0-100%).
 - b) Data memory occupation in %.

-
- c) Real time clock circuit state: **tick** - OK, **exclamation mark** - low voltage of the real time clock circuit detected, the time could be incorrect!
 - d) Activities of the Alarm out signal: *is not supported*.
 - e) MUTE activated: **tick** - was activated (alarm is still active), **field without a tick** - was not activated (or the alarm is inactive).
 - f) Activities of EN signal: *is not supported*.
 - g) battery voltage: range from 3.4 V (completely discharged battery) to 4.5 V (new or just charged battery)
 - h) device internal temperature (affects the battery charging)
 - i) cold junction temperature of the thermocouples
 - j) Multilogger firmware version.

2. Viewing settings ---

Allows to view the following settings:

- **record settings** (recording interval, cyclic record, record on alarm, record of the average and min/max values per logging interval)
- **general settings** (LCD backlight intensity, battery type, menu language, date and time in the device)
- **alarm limits** (limit values, hysteresis and delay for each existing channel and alarm. You can change channels using the arrow keys).
- **alarms indication** - information about settings of alarm signalization (optical, audio, Alarm Out signal) and if it is enabled to temporarily deactivate the alarm signalization (MUTE function)
- **memory occupation** - information about alarm limit of data memory occupation and signalization of this alarm (optical, audio, Alarm out signal)
- **Ethernet interface** – *is not supported*

3. Display settings ---

Allows to set the parameters of the displaying:

- Font size (large, medium, small)
- Displaying input description of the measured quantity (yes, no)
- Order of the displayed channels (based on the input number, based on the channel number, selection)

4. Device Settings ---

Access to this submenu can be protected by a PIN1 code. Recording is stopped after entering into editing mode. If no key has been pressed for 5 minutes in the editing mode, the device restarts with the last settings. The following parameters can be edited:

- **recording parameters** (recording interval, start/stop recording)
- **general settings** (LCD backlight activity&intensity, battery type, menu language)
- **alarm limits** (limit values and alarms directions can be set for each existing channel and alarm. You can switch from one channel to another using the arrow keys).
- **alarm indication** - enable or disable of alarm signalization (optical, audio, Alarm out signal). Setup of MUTE function - temporary deactivation of audio and/or Alarm out signalization.
- **memory occupation** - limit and signalization (optical, audio, Alarm out signal)
- **Ethernet interface** – *is not supported*

Note: the Multilogger M1200E is not equipped with a signal *Alarm out*

5. Erase Min/Max ---

Erase of the Min/Max memory of either all measured quantities (“All channels” option) or selected measured quantities (“Individual channels” option) by the user. This function can be protected using PIN2. The Min/Max values will be erased automatically if the device happens to be without any power supply, for example, when replacing its batteries.

6. Deactivation of Latched alarm _____

If the “Latched alarms” function is enabled in the device configuration, the active alarms are not reset when the measured values return back to the allowed limits. Instead, they remain active until they are deactivated by the user. They thus warn us that “something was happening” during the monitored period, i.e. that the alarm limits were exceeded. This function can be protected using PIN2.

7. Device information _____

The 32-character user description of the Multilogger, device model and its serial number are displayed here. The next screen displays a summary of the configuration of individual inputs.

Connecting with the computer

You can connect the Multilogger to the computer through the USB communication interface. This is way of the fast connection for short distances (up to 5 m, communication speed of 460,800 Bd). Connect the device to the computer using the supplied cable, launch the SW and add Multilogger to the list of your Comet devices.

Software COMET Vision

Hardware and system requirements _____

- the Windows 10 and later or the Windows Server 2016 and later
- 2 GHz dual-core CPU
- RAM 4 GB

Program description _____

The *COMET Vision* software can be used for device configuration and for obtaining recorded data and currently measured values. The device can be connected via USB, Ethernet or a serial port.

The program is available for free (at www.cometsystem.com). This program lets you connect any number of devices that can work simultaneously (for example, downloading data from several devices at the same time, having multiple displays launched, etc.) and will also give you access to advance functions (for example, charts, statistical overview of the recorded data, custom display, export to the database, etc.).

Adding the Multilogger to the list of Comet devices _____

The device can be added by clicking on the “add device” button (you can find it under the “Welcome” menu, which is displayed upon the first launch of the program, or also under the “Home page of the device” menu, under the “Devices” option). A menu with a selection of connection types is displayed (USB, Ethernet, Serial), where for USB connection you can select device from the list of offered devices. Finally, confirm you selection using the “Finish” button and the device will be added.

Automatic detection can be used for devices connected via USB. Once the device is connected to your computer, the device is automatically added to the list of Comet devices (within about 5 seconds - time necessary for the device initialization).

When connecting device via USB the baudrate is 460,800 Bd.

How to work with the program _____

The main menu of the program is on the right side with items: "Home", "Devices", "Files" and "Online Displays". These components control appearing bookmarks. Each item has its bookmarks, one of them named "Home" is similar for all items. The other options are specific for each item.

Device setup using software

Upon being the Multilogger switched on using the red button, the device begins to take measurements and to record and evaluate alarms according its user configuration. Complete configuration of the device can be done using the *COMET Vision* software. Some parameters can be changed from the device keyboard. When editing the Multilogger configuration, the device normally works, however, access to some of its functions is limited (downloading records, editing of the device configuration by other users).

Device configuration basics

- Connect the Multilogger with your computer and launch the *COMET Vision* software.
- If the software is not communicated with this device yet, add Multilogger to the list of your Comet devices. For more information see part “CONNECTING THE MULTILLOGGER WITH THE COMPUTER”.
- If the Multilogger is correctly connected, the *Device Home* panel displays its current status.
- Click on the *Configuration* button. The device configuration is loaded and you can view or edit it.
- When you make a configuration change of any items, the SW goes to the editing mode and limits the device access for other users now.
- Upon a long user inactivity period, the editing configuration mode is automatically terminated.
- Finally, save the new configuration to the Multilogger (*Apply changes*).

Device configuration items

General - Information

Here are displayed the basic information about the connected Multilogger. It includes its name (*Device name*), which is used for identifying your device and its measured values. The instrument can be named according to of its application or you can use the default name. The maximal length of the *Device name* is 32 characters - use letters, numbers, underscore characters, etc. Moreover, this panel states the serial number, model name and firmware version.

General - Preferences _____

Here you can select language localization (*Language on the device terminal*) and temperature unit (*Default temperature unit °C/°F*).

General - Date and Time _____

Here you can set the date and time in Multilogger (*Date and Time*). In the device is running the local time. Use *TimeZone*, if you can determine its relation to UTC. This information will be available for all timestamps from the device (record, online monitoring). The Multilogger does not allow for automatic changes between the summer and winter times.



ATTENTION - after change the date and time, the recorded data in the Multilogger will have to be deleted!

General - Advanced - Energy _____

The Multilogger running in the standard mode will measure all inputs once per second. The advantage is a fast response of the device, the disadvantage is its higher current consumption if the device is powered from batteries only. If you operate the Multilogger from batteries for a long time and you do not need a fast response time, you can use the energy saving mode (*Energy saving mode*), under which the device consumption from the batteries will significantly decrease, however, the measurement interval will be extended to 10 seconds. Consumption details can be found in the *Technical Information*.

General - Advanced - Device start _____

Here you can disable the “Off key” of the device.

General - Advanced - LCD Display

These settings are used for optimizing the backlight of the display in relation to your application. As a default, the Multilogger is set in a way that the backlight (*LCD backlight activity*) is activated only for several seconds upon the last key pressing. If, however, you need to ensure a good visibility of the display in the mains powered fixed installation, turn on the backlight activity only when the external power supply is on and choose a suitable intensity (*LCD backlight intensity*). If the backlight is permanently turned on while Multilogger is powered from the batteries, they discharge relatively fast, therefore do not use this setting. Turn the backlight off for applications, for which is required the longest battery life.

Record

This options are used for controlling the record functions of the Multilogger. Recording can be turned on and off as needed (*Recording On/Off*). However, if the record is turned off and then you turn it on again, this takes up 0.1% of the free memory capacity. Use the *Cyclic record* if you require the device to continue the recording even when the data memory is completely full. In this case, the oldest data are replaced by new ones. If you do not use this option, the recording will stop once the memory is full. Another important parameter is the *Recording interval*. It can be set from 1 second to 24 hours (see the *Technical Information*). The recording is performed in integral multiples of a set interval. For example, if you turn the device on at 5:05 a.m. and if you have set the logging interval at 1 hour, the first data will be recorded at 6:00 a.m., next ones at 7:00 a.m., etc.

Recording can be continuous or, alternatively, records can be taken only if any measured quantity is in the alarm state (the system alarms does not trigger recording). Moreover, Multilogger with binary input No. 3 also offer the option to control the recording by the status of this binary input. These settings can be performed in the section *Recording mode*.

By default, the device records the actual values at the time of the recording interval. However, if continuous recording is on (see above), you can select recording of average, minimal and maximal values during recording interval. These settings can be performed in the section *Recorded values*.

The last thing to do when configuring the recording is to select the measured quantities that you want to record (see the *Inputs* panel described below).



ATTENTION - upon changing cyclic ↔ non-cyclic recording, you will need to erase all the recorded data saved in the device!

Alarm events - Signalization

The Multilogger allows to evaluate alarm states, which can come from the measured quantities or which can signalize some device problem (exceeding of the data memory occupation limit, system alarms). For each alarm it is possible to assign the method of their signaling to the user.

Alarms can be signaled using the LED diodes directly on the Multilogger (*Optical signalization - LED*). Since the Multilogger can work in the battery mode, additional options are available for minimizing the current consumption. For a state without an alarm can be selected green LED indication. When the device is powered from batteries, you can select more energy economical mode, under which the LED diodes only shortly blink in the case of an alarm.

In addition, the alarm can be signaled acoustically with characteristic sound that is repeated at regular interval. Service personnel can easily confirm the audio signal and thus make it silent until a new alarm occurs. These settings can be performed in the section *Mute of signalization*.

Alarm events - Preferences

In the standard mode, the alarm exists if the measured value is out of limits, and the alarm becomes inactive if the measured value returns to its limits. In some cases it is suitable that the user, who comes to the device after a longer period of time, can easily make sure that no alarm has occurred while he/she was gone. If you activate the *Latched alarms* option, all alarms that occur in the Multilogger will remain active until the service personnel is not confirmed them.

Here you can also allow remote erasing of the alarm memory and remote deactivation of alarm signalization from the software *COMET Vision* or from the web (*Remote Mute & Erase of Latched alarms*); moreover, you can permit or forbid alarm deactivation from the device keyboard (*Local Mute enabled*). To protect access to these functions, you can use the PIN2 code (Security panel).

Furthermore, you can allow alarm evaluation here only on certain days of the week and within defined range of hours per day. It is not suitable to combine this setup with the above described *Latched alarms* option.

Alarm events - Mute of signalization _____

The *Mute* function is used for deactivating alarm signalization by the user. It can be optionally applied to audio signalization. It can be performed from the keyboard or from the software *COMET Vision*. To protect access to these functions, you can use the PIN2 code, which the operation personnel must enter. This function deactivates enabled alarm signalizations until a new alarm occurs. The deactivation can be permanent (until a new alarm occurs) or temporary (if the alarms remain active even after selected time out, the signalization is restored).

Alarm events - Memory occupation _____

If you need to indicate exceeding of your specified limit of the data memory occupation, use the setup in this section. The signalization can be selected as optical (red LED diode), audio, or by the means of the ALARM OUT output activation or sending email to selected recipients.

Alarm events - System failure _____

The options in this section allow for setting up the *System alarms* which respond to the Multilogger or probes malfunction. The signalization can be selected as optical (red LED diode), audio, or sending email to selected recipients.

The Multilogger can respond to the following states:

- a) *Measurement error on any channel* ... for example, a disconnected or damaged probe
- b) *Device configuration error* ... an unexpected device configuration error
- c) *Selftest error* ... empty battery
- d) *External power lost* ... failure of the external power supply source

Security

The Multilogger allows an easy security option by the means of PIN codes:

- PIN1: protection against unauthorized changes of the device configuration (from a PC or device keyboard), erasing of data memory and counter erasing
- PIN2: protection against unauthorized alarm deactivation (*Mute*), confirmation of alarm memory (*Latched alarms*) and erasing of the Min/Max values

Inputs

Here you can specify the quantities that you will measure on every one inputs, their recording and alarm states. You can see a simple list of all inputs and measured quantities on the screen.

First of all, specify the probe or signal types connected to each input (*Settings* button). Here you also choose the measured quantities that you will acquire from this input. You can also decide not to use a specific input, in this case click on *Clear* button or remove all set measured quantities. You can name the input by your own name (*Input name*), which you will then see by all measured values. Once you are done with this configuration, you can return back to the list of inputs and measured quantities.

Now, when you have correctly set your inputs and selected measured quantities, you can configure them in more details using the *Edit* button. For each measured quantity, you can choose if it should be recorded (*Recording*) and if you wish to use the default setting (*Basic settings - default*) of the physical unit (6 characters), short description of the

measured quantity (4 characters) and number of decimals. However, you can also opt for your own setup (*Basic settings - custom*) and enter the stated items manually. If you need to convert the measured values to different values using a two-point linear transformation, turn on the User calibration function (*User calibration*). For example, you can use it for converting output voltage of sensor to a different physical quantity or for applying recalculation to the measured values.

Example of user calibration settings for a heat flux sensor with a voltage output (-50 to +50) mV connected to the voltage input of the Multilogger (range -60 mV to +140 mV), with a range of the sensor between -1000 Wm⁻² and +1000 Wm⁻²:

Upper point B: Input value: +50 will be shown as 1000

Lower point A: Input value: -50 will be shown as -1000

In the next step, set alarms for individual measured quantities. You can set up to 2 alarms for each measured quantity (*Alarm 1* and *Alarm 2* buttons). Each alarm has to be enabled first (*On/Off*).

Next, select if the alarm occurs upon exceeding or dropping under the given limit value (*value is greater than / value is lower than*) and enter this limit. For binary inputs only define the state of the input. Next, you need to specify the alarm delay (*for the duration of*), which is used for eliminating short-term exceeding of the limit value. Hysteresis has a similar function (*Alarm hysteresis*) - it is used to prevent alarm oscillation when the measured value fluctuates nearby the alarm limit. We recommend not to set it at zero. We have hereby completed the setup for alarm occurrence. Now we just need to specify if the alarm will be indicated optically on the Multilogger (*Optical signalization - LED*), acoustically (*Activate internal audio signalization*), by the ALARM OUT output (*Activate ALARM OUT output*) or by submitting a warning email (*Send email message ...*).

In some application, we want to calculate other values from the measured ones, and we want to be able to record them and to create alarm states. The Multilogger allows this by the means of several simple mathematical operations (difference, linear equation, multiplication and division). This way, you can, for example, easily calculate the difference between the surface temperature and the dew point of the air. Calculated values can be defined on the section with a list of inputs and measured quantities by clicking on the given line button *Calculated - Add*. Their further settings are specified similarly to the measured quantities (with the exception of the *User calibration*, which cannot be used for the calculated quantities).

Applications notes

Recommended settings for the portable application _____

In this application, the Multilogger is powered from batteries and a fast response time and an easy battery recharge after the measurement are required. Recorded data are downloaded after measurement.

We recommend to use the Multilogger with NiMH accumulators; specify the following device configuration:

- NiMH accumulators (if they are installed).
- Do not turn on the *Energy saving mode*. The Multilogger will perform measurement with a fast sampling (1 second).
- Switch off the display backlight or allow it only upon pressing a key. Active backlight drastically reduces the battery life. However, even when it is permanently on, the Multilogger with fully charged batteries will operate about one week with the lowest backlight intensity (25%).
- Switch off the optical alarm signalization using the LED diodes or, if necessary, allow only the orange and red LED diodes working in a flashing mode while the Multilogger is powered from batteries.
- If you are not going to use the audio alarm signalization, turn it off.

Empty batteries can be easily recharged once the measurement is completed using the fast charge option.

Recommended settings for the stationary application _____

In this application, the Multilogger is powered from an external power supply most of the time. It is required that the measurements and recordings continue even during any power supply failure. Once the power supply is restored, the data acquired during the given power failure must be available and the batteries have to be automatically recharged.

We recommend to use the Multilogger with NiMH accumulators; specify the following device configuration:

- NiMH accumulators (if they are installed).
- Do not turn on the *Energy saving mode*. The Multilogger will perform measurement with a fast sampling (1 second).

-
- Switch on the display backlight as needed. If it is necessary to make the measured values on the Multilogger well visible all the time, turn the backlight on only when the device is powered from an external power supply.
 - Use the optical alarm signalization using the LED diodes as needed.
 - Set the audio alarm signalization as needed.
 - If you want to operate the Multilogger “remotely”, disable “Off key” on its keyboard (*COMET Vision* software, option *General - Advanced - Device start*). You will thus prevent unauthorized or unwanted device turn-off by unqualified personnel. In these cases, it is also advisable to limit access to the device configuration from the keyboard using PIN codes.

After an external power failure, when the device was running from the batteries for a while, the batteries are automatically recharged by low current as soon as the external power is restored.

Recommended settings for a long time battery powered application

In this application, the Multilogger is powered only from batteries and a fast response to changing measured quantities is not required, however, it is required that the device runs from the batteries as long as possible. Recorded data are downloaded after measurement.

We recommend to use the Multilogger with NiMH accumulators; specify the following device configuration:

- NiMH accumulators (if they are installed).
- Switch on the *Energy saving mode*. The Multilogger will perform measurements with a slow sampling (10 second).
- Switch off the display backlight or allow it only upon pressing a key. Permanently activated backlight drastically reduces battery life.
- Switch off the optical alarm signalization using the LED diodes or, if necessary, allow only the orange and red LED diodes working in a flashing mode while the Multilogger is powered from batteries.
- If you are not going to use the audio alarm signalization, switch it off.

Empty batteries can be easily recharged once the measurement is completed using the fast charge option.

How to set the Multilogger for measuring the difference of two temperatures _____

To do that, use the calculated measured quantity (*Calculated*). First of all, select input quantities that will be used in the calculation formula. Next, set the other items analogically to the other measured quantities. In addition to the calculating of difference, other simple mathematical operations are possible.

System alarms and how to work with them _____

System alarms are used for diagnostic functions of the device and probes connected to it. A system alarm signals a malfunction or damage of the Multilogger or its probe. Unlike the alarms from measured quantities which signal the problem of the technology that the Multilogger monitors. A system alarm can be reported to a different person than alarms from the measured quantities.

Backup and restore of device configuration _____

If you have set the whole system and you need to back up its setting with the possibility to upload it to the same or even different Multilogger, download recorded data from device. The saved file contains complete configuration of the Multilogger, which you can upload back to the device.

How to set a variable alarm limit _____

In some applications, you need the alarm limit to depend on another measured value.

Example:

We require that the alarm must be activated when temperature T1 (input IN1) becomes by 5 °C higher than temperature T2 (input IN2). In this case add another calculated quantity that will be the difference of both measured temperatures T2-T1. The alarm limit for this quantity shall be 5 °C. The alarm then occurs if $(T2 - T1) > 5$ °C.

Selftest error

The selftest is used for monitoring the state of the batteries. If the Multilogger reports this error, the batteries are empty. You can check the battery status in the System information menu or in the software *COMET Vision* on the Device home page. If the battery voltage drops under 3.45 V, the Multilogger reports a self-test error. A drop of the power supply voltage is also indicated by the given symbol  on the device status line. The batteries have to be recharged or replaced.

Measurement accuracy problems

In a majority of cases, incorrectly measured temperature values are caused by an incorrect position of the probes or measuring method. Some comments related to this topic are shown in the next Chapter, *Operation and maintenance recommendations*.

When measuring temperature using thermocouples, you have to make sure that neither the measuring ends, nor conductors are connected to any conductive parts that may cause unwanted couplings. This may, in exceptional cases even cause damage the device.

If the Multilogger reports an error state, you can find more information in *Appendix 1 - Selected error messages*.

Another group of problems are random spikes of the measured values. Most commonly, they are caused by a source of electromagnetic interference located in the proximity of the device or cables. Furthermore, you have to also make sure that the insulation of the cables is not damaged and that conductors thus do not make any incidental connections with other metal parts.

PC communication problems

If the Multilogger communicates via USB interface, do not use cables longer than 5 meters. Connecting and disconnecting the cable while the communication is in progress can cause temporary unavailability of the USB device in the computer. In this case, it may be necessary to close and re-launch the SW (including the communication service). If this does not help, restart the computer.

Operation and maintenance recommendations

Device operation in various applications _____

Before application it is necessary to consider if Multilogger is suitable for required purpose, adjust optimal configuration and create instructions for its periodical metrological and functional inspections. **Since the Multilogger can be powered from the power mains, it is necessary (depending on the character of the application) to secure the appropriate electric revision of its installation and its regular inspections.**

Unsuitable and hazard applications: The Multilogger is not designed for applications, where failure of operation could cause endanger of health or function of other life supporting devices. In applications, where failure of Multilogger could cause loss on property, it is recommended to amend system of independent indication device to monitor this state and avoid damages. You have to be especially careful with regard to the alarm output with a connected external audio unit, functionality of which is depended on external power supply source.

Locations of temperature sensors: place them to locations with sufficient air flow and where most critical point is supposed (in accordance with application requirements). The sensor has to be sufficiently inserted into the measured area or sufficiently connected to it in some other way, thus preventing the measured values to be influenced by undesired heat coming from the conductors. *When monitoring temperature in an air-conditioned warehouse, do not place the sensor in the path of the direct air flow from the air-conditioning units. The thermal field can sometimes be very inhomogeneous (for example, in large chamber refrigerators) and the deviances can reach up to 10 °C. Similar deviances can be found in deep freezers (used, for example, for freezing blood etc.).*

Recommendations for metrological verification _____

Metrological verification is performed in accordance with application requirements specified by the user. In some cases, calibrations must be performed by the accredited laboratory. The manufacturer recommends to perform these verifications once a year.

Note: *accuracy of Multilogger input means accuracy of input itself without probes.*

When verification of thermocouple inputs it is necessary to take into account that cold junction compensation is performed inside of Multilogger, where temperature is somewhat higher than ambient temperature on the outer connector. This fact can sometimes cause problems when performing verifications using the electric simulators of the thermocouples. The best way is to do the temperature verification together with the thermocouple.

Recommendations for periodical inspections _____

The manufacturer recommends to perform regular inspections of the system, into which the Multilogger is included. The interval and range of the inspections depends on the particular application. The following inspections are recommended for stationary installations:

- metrological verifications
- regular revisions and inspections subject to the intervals specified in the corresponding standards
- assessments of all problems that occur since the last inspection
- visual inspection of the device and checking of the connectors
- device functionality inspections (i.e. the functions used for a given application):
 - a) verification of data transfer to computer
 - b) verification of alarms - change input value to activate alarm and check display message
 - c) check the battery voltage (in device menu)
- Verification of cabling - check the connection quality of cables, check visually entire cable length for damage and the route of cables for interference, especially whether some parallel power wires are not near.
- Visual inspection of sensors - perform their visual inspection and make sure no water has leaked inside the sensors; moreover, verify that their locations are suitable from the perspective of measuring accuracy as well as possible interference.
- Make a verification protocol.

Service recommendations _____

Technical support and service are performed by the devices' distributor. Its contact is given in the warranty certificate, supplied with the Multilogger.



ATTENTION - damage due unauthorized manipulation will cause the warranty to expire!

Placing out of operation after the end of the device life _____

Disconnect the power, remove batteries and return data logger to the supplier or specialized company as electric waste.

Technical parameters

Power supply

The Multilogger is powered from batteries located under the removable cover on the rear side of the device. An external power supply source can be also connected to the Multilogger. When the device is connected to an external power supply, the batteries are not used. Batteries can be recharged in the device.

Batteries

Batteries:

3 x AA alkaline battery 1.5 V

Recommended accumulator type:

3x AA NiMH rechargeable batteries Sanyo ENELOOP
1,900 mAh, 1.2 V

*When NiMH accumulators are used, **it is necessary** to set the charger in the device configuration, i.e. to set the Multilogger for NiMH accumulators.*

Operating time of fully charged NiMH batteries:

> 1 month in the standard measuring mode
approximately 6 month in the power saving mode

Applies to Multilogger with fully charged batteries of the recommended type; when the display backlight, LED indication and audio signalization are turned off.

Current consumption when the Multilogger is turned off:

< 15 μ A

Backing up of date and time in the Multilogger:

< 5 minutes after removing the batteries and with the device turned off

If the Multilogger is without a power for a longer time, the date and time settings in the device could be lost and will have to be set up again. When the Multilogger is connected to an external power supply, the date and time are not lost when batteries are removed.

External power input

Power voltage:

+5 V DC (+4.9 V to +5.5 V)

Maximum voltage applied to the power input:

+ 6 V DC max.

Absolute limit above which may be damaged the device!

Current consumption from external power input when the Multilogger is turned off:

approximately 1.5 mA

External power supply connection possibilities:

- Circular power connector 5.5 / 2.1 mm
- USB cable

The Multilogger does not allow increase the supply current of the PC USB interface. Therefore the fast battery charging does not have to work correctly from USB.

Battery charger

Slow charging mode current:

approximately 10 mA

Fast charging mode current:

approximately 350 mA

Fast charging has to be activated by the Multilogger user. During the fast charging, the Multilogger does not take any measurements nor recording and does not communicate with the computer.

Fast charging time:

Up to 6 hours

Fast charging restriction:

Allowed in ambient temperature from 0 °C to 40 °C.

USB communication interface

Compatibility:

USB1.1 and USB 2.0

Connector USB:

mini USB

Vendor ID:

0403

Product ID:

6001

Baudrate:

460,800 Bd

Measuring, data memory and real time clock

Measuring interval:

1 s in standard mode (default)
10 s in the energy saving mode

Recording interval:

1 s, 2 s, 5 s, 10 s, 15 s, 30 s,
1 min, 2 min, 5 min, 10 min, 15 min, 30 min,
1 hour, 2 hours, 3 hours, 4 hours, 6 hours, 12 hours,
24 hours.

Memory capacity:

Up to 1,000,000 values for non-cyclic record
Up to 600,000 values for cyclic record

Duration of data downloading:

< 5 minutes for a 100% data memory occupation using
the USB interface

Real time clock stability:

max. 200 ppm \pm 5 ppm/year at 23 °C \pm 10 °C

Electromagnetic compatibility

The device is tested according to standard EN 61326-1: 2006, Article 6, Table 1.

Emission:

EN 55011: class B

Immunity:

EN 61000-4-2: class A (4/8 kV)

EN 61000-4-3: class A (3V/m)

EN 61000-4-4: class A (0.5/1 kV)

EN 61000-4-5: class A (external power supply only)

EN 61000-4-6: class A (3 V)

Operation and storage conditions

Operation temperature:

(-10 to +60) °C

Operation humidity:

(5 to 85) %RH without condensation

Operation environment:

chemically non-aggressive

Storage temperature:

(-30 to +80) °C

Storage humidity:

(5 to 90) %RH

Mechanical characteristics

Dimensions (h x w x d):

178 x 95 x 37 mm without cables and connectors

Weight:

approximately 330 g, including batteries

Protection:

IP20

Included mounting accessories:

MLP001 - wall holder for Multilogger

Optionally mounting accessories:

MLP002 - lockable wall holder for Multilogger

MLP003 - magnetic holder for Multilogger

Technical parameters of the inputs

The device is equipped with a white, uncompensated miniature thermocouple connector. Compensation of the cold junction temperature is performed by measuring the temperature inside of the device in the area between the input connectors. The inputs are not galvanically isolated from each other, nor from other signals connected to the device. In order to secure correct measurements, you need to prevent undesirable coupling. Furthermore, the Multilogger has to be placed in its working position and temperature stabilized.

Required measured quantities can be selected for each input using the *COMET Vision* software. These quantities can be recalculated using two-point linear transformation, displayed, recorded to the memory or used for alarming. In addition, the Multilogger allows creating of calculated quantities from the measured values using simple mathematical operations.

The Multilogger allows measure temperature in °C or in °F. If you use °F, the below stated ranges and accuracy have to be recalculated to °F.

- **Thermocouple of the “K” type (Ni-Cr / Ni-Al)**

Measured quantity: temperature
Range: (-200 to 1,300) °C
Accuracy without probes: \pm (0.3% from the measured value + 1.5 °C)
Resolution: better than 0.1 °C *(to achieve this value, the corresponding number of decimals must be set)*
Cold junction: compensated in the temperature range of (-10 to 60) °C

- **Thermocouple of the “J” type (Fe / Cu-Ni)**

Measured quantity: temperature
Range: (-200 to 750) °C
Accuracy without probes: \pm (0.3% from the measured value + 1.5 °C)
Resolution: better than 0.1 °C *(to achieve this value, the corresponding number of decimals must be set)*
Cold junction: compensated in the temperature range of (-10 to 60) °C

- **Thermocouple of the “S” type (Pt-10 % Rh / Pt)**

Measured quantity: temperature
Range: (0 to 1,700) °C
Accuracy without probes: \pm (0.3% from the measured value + 1.5 °C)
Resolution: better than 0.1 °C *(to achieve this value, the corresponding number of decimals must be set)*
Cold junction: compensated in the temperature range of (-10 to 60) °C

- **Thermocouple of the “B” type (Pt-30 % Rh / Pt-6 % Rh)**

Measured quantity: temperature
Range: (100 to 1,800) °C
Accuracy without probes: \pm (0.3% from the measured value + 1 °C) in the range of (300 to 1.800) °C
Resolution: better than 0.1 °C *(to achieve this value, the corresponding number of decimals must be set)*
Cold junction: uncompensated

- **Thermocouple of the “T” type (Cu / Cu-Ni)**

Measured quantity: temperature
Range: (-200 to 400) °C
Accuracy without probes: \pm (0.3% from the measured value + 1.5 °C)
Resolution: better than 0.1 °C (to achieve this value, the corresponding number of decimals must be set)
Cold junction: compensated in the temperature range of (-10 to 60) °C

- **Thermocouple of the “N” type (Ni-Cr-Si / Ni-Si-Mg)**

Measured quantity: temperature
Range: (-200 to 1,300) °C
Accuracy without probes: \pm (0.3% from the measured value + 1.5 °C)
Resolution: better than 0.1 °C (to achieve this value, the corresponding number of decimals must be set)
Cold junction: compensated in the temperature range of (-10 to 60) °C

- **DC voltage from -60 mV to +140 mV**

Range: (-60 to +140) mV
Accuracy without probes: \pm 100 μ V
Resolution: better than 1 μ V (to achieve this value, the corresponding number of decimals must be set)
Input impedance: approximately $10^7 \Omega$
Minimum input voltage: -0.2 V
Maximum input voltage: +3 V
Connector: miniature uncompensated thermocouple connector (white color)

- **DC voltage from -18 mV to +18 mV**

Range: (-18 to +18) mV
Accuracy without probes: \pm 20 μ V
Resolution: better than 0,5 μ V (to achieve this value, the corresponding number of decimals must be set)
Input impedance: approximately $10^7 \Omega$
Minimum input voltage: -0.2 V
Maximum input voltage: +3 V
Connector: miniature uncompensated thermocouple connector (white color)

Appendixes

Appendix 1: Selected error messages

Error	Description and solution
Error 1	The value is out of the input range (low limitation). - shorted Pt1000/M probe - negative input voltage (thermocouples, 0 to 10 V) - reverse input current (for 0 mA to 20 mA range) <i>Check the connected probes and signals!</i>
Error 2	The value is out of the input range (high limitation). - disconnected Pt1000/M probe - too high input voltage (thermocouples, 0 to 10 V) - too high input current (for 0 mA to 20 mA range) <i>Check the connected probes and signals!</i>
Error 4	Digi_/M probe communication error. <i>Check the connected probe - it is probably not connected or it is not Digi_/M line probe!</i>
Error 5	Digi_/M probe communication error. <i>The probe is probably damaged. Try another probe!</i>
Error 7	Pt1000/M probe communication error. <i>Check the connected probe - it is probably not connected or it is not Pt1000/M line probe!</i>
Error 8	Cold junction temperature measurement error. <i>The Multilogger is outside of the range of operational temperatures or the device is damaged.</i>
Error 9	The value is out of the measuring range (for example, temperature from RTD and from the thermocouple probes). <i>The probe could be defective, the thermocouple type could be different and there may be an undesirable coupling among inputs or incorrect calibration of the Multilogger. Try a different probe, check the cables and unwanted coupling.</i>
Error 10	The pressure sensor is not available. <i>Send the Multilogger for repair.</i>
Error 11	The counter does not have valid data, the Multilogger has been without batteries. <i>Erase the counter using the SW and repeat measurement.</i>

Error	Description and solution
Error 12 : Error 16	The CO ₂ concentration sensor is not available or does not work correctly. <i>Send the Multilogger for repair.</i>
Error 19	The source value for the calculated channel is not available. <i>Check calculated channel settings and its source values.</i>
Error 20	Calculation error, incorrectly calibrated device. <i>Send the Multilogger for repair.</i>
Error 21	Counter overflow. <i>Erase the counter using the SW and repeat measurement. If you do not want to be considered the counter overflow as error you can change this setting of the input.</i>
Error 22	Internal voltage error. Undesirable coupling among the inputs, incorrect connection, damaged cables, damaged device. <i>Check the input connections and the connected cables.</i>
Error 50, Error 53 : Error 56	Device configuration error, damaged configuration. <i>Download the configuration to the SW, check of the settings of individual items and save them back to the Multilogger.</i>
Error 51	The probe of the Digi/M line contains invalid calibration constants. <i>Send the probe for repair or contact the manufacturer.</i>
Error 52	The probe of the Pt1000/M line contains invalid calibration constants. <i>Send the probe for repair.</i>
Error 90 Error 91	The Ethernet interface - the measured value is out of numerical range. <i>Verify the measured value on the device display, contact the manufacturer.</i>
Error 128 : Error 255	Communication error. <i>Repeat the communication, contact the manufacturer.</i>

Appendix 2: Input circuits

